

PORTABLE PUMP KIT

Quantity
Required

**HOSE ASSEMBLY - 4" x 50 FT.
NON-METALLIC**

NSN 4210-01-220-6648

WT. 60.0 lbs. VOL. 4,064.0 in³

Helpful Hints:

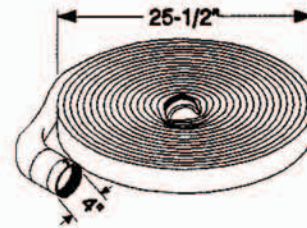

1

Actual Inventory:

**HOSE ASSEMBLY - HARD RUBBER
SUCTION, 3" x 10 FT.**

NSN 4210-00-725-9234

WT. 30.0 lbs. VOL. 3,000.0 in³

Helpful Hints:

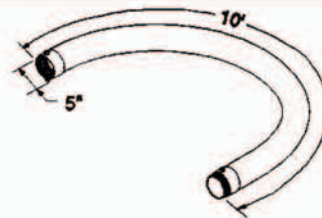

1

Actual Inventory:

**HOSE ASSEMBLY - NON-METALLIC
JUMPER DISCHARGE HOSE FOR P-250
TO WYE-GATE/SIAMESE CONNECTION**

NSN 4210-01-273-4727

WT. 6.8 lbs VOL. 607.5 in³

Helpful Hints: 2-1/2" male/female NHT couplings.

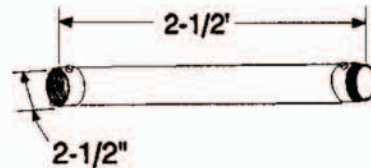

1

Actual Inventory:

**HOSE ASSEMBLY - RUBBER EXH. HOSE, BLACK
2" x 20 FT.**

NSN 4210-00-776-0657

WT. 23.0 lbs. VOL. 2,300.0 in³

Helpful Hints:

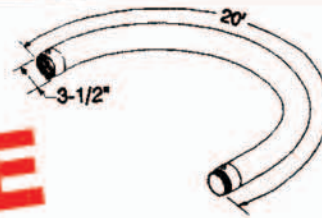

1

Actual Inventory:

DELETE

PORTABLE PUMP KIT

Quantity
Required

KIT - PORTABLE PUMP
ACCESSORIES-DC

1H 0000-LL-CQA-2460

This kit identifies all equipment used for the function of providing accessories to the P-250 (MOD 1 & MOD 2) and P-100 pumps to function as a dewatering/fire fighting pump. Individual items are listed on AEL #2-880044270 and in alphabetical order in this guide.

AURAL PROTECTOR, HEADSET -

NSN 4240-00-759-3290

WT. 0.6 lbs VOL. 108.0 in³

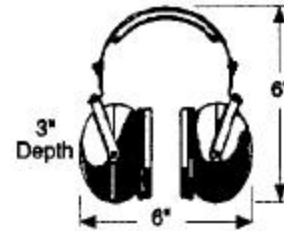

5

Helpful Hints:

Actual Inventory:

BAG, LINEMAN TOOL -

NSN 5140-00-288-7763

WT. 3.1 lbs VOL. 594.0 in³

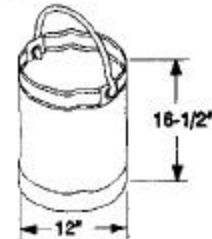

1

Helpful Hints: Stow small pilferable items of equipment.

Actual Inventory:

CAN - FUEL
P-250 (MOD 1 or MOD 2)

NSN 2910-01-222-7294

WT. 45.0 lbs. VOL. 2,340.2 in³

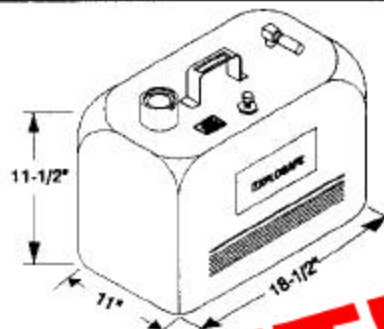

1

Helpful Hints:

Actual Inventory:

DELETE

PORTABLE PUMP KIT

Quantity
Required

CONNECTION - TRI GATE
2-1/2" INLET x TWO 1-1/2" OUTLETS X
ONE 2-1/2" OUTLET

NSN 4210-01-038-6001

WT. 15.3 lbs **VOL.** 425.5 in³

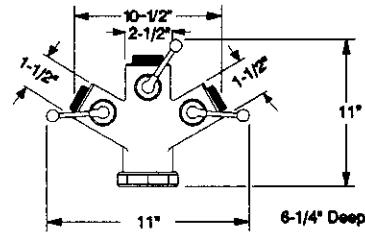

1

Helpful Hints: To protect male connectors flush and coat with silicone after use.

Actual Inventory:

EDUCTOR - PERI-JET
2-1/2" INLET x 4" OUTLET

NSN 4320-00-256-8206

WT. 35.0 lbs. **VOL.** 2,720.0 in³

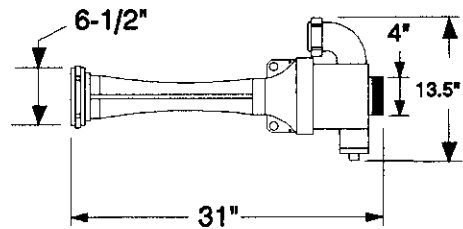

1

Helpful Hints: APL #740000002. Protect bottom 4" male connector threads. Flush after each use. Coat female and male threads with silicone after use.

Actual Inventory:

GASKET - WASHER, HOSE 2"

NSN 5330-00-239-1875

WT. 0.1 lbs **VOL.** 0.5 in³

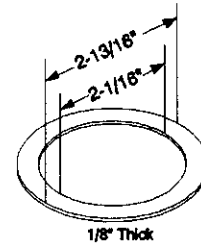

5

Helpful Hints: For 2" exhaust hose.

Actual Inventory:

PORTABLE PUMP KIT

Quantity
Required

GASKET/WASHER - 3" RUBBER

NSN 5330-00-239-1879

WT. 0.2 lbs

VOL. 1.4 in³

Helpful Hints: For 3" suction, female connector.

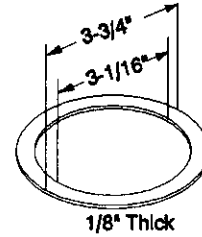

5

Actual Inventory:

GASKET/WASHER - 4" RUBBER

NSN 5310-00-239-1882

WT. 0.2 lbs

VOL. 1.5 in³

Helpful Hints: For eductor and 4" hose female connector.

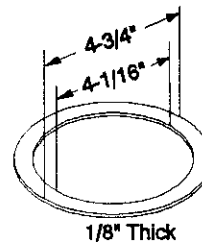

5

Actual Inventory:

GASKET/WASHER - 1-1/2" NON-METALLIC

NSN 5330-00-239-1873

WT. 0.1 lbs

VOL. 0.5 in³

Helpful Hints: For 1-1/2" fire hose.

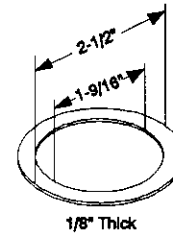

10

Actual Inventory:

GASKET/WASHER - 2-1/2" NON-METALLIC

NSN 5330-00-246-2914

WT. 0.1 lbs

VOL. 1.3 in³

Helpful Hints: For 2-1/2" fire hose.

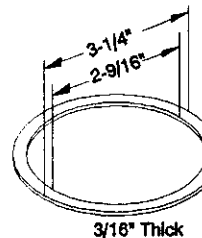

1

Actual Inventory:

PORTABLE PUMP KIT

Quantity
Required

**HOSE ASSEMBLY - 4" x 50 FT.
NON-METALLIC**

NSN 4210-01-220-6648

WT. 60.0 lbs. VOL. 4,064.0 in³

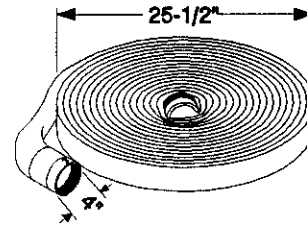

1

Helpful Hints:

Actual Inventory:

**HOSE ASSEMBLY - HARD RUBBER
SUCTION, 3" x 10 FT.**

NSN 4210-00-725-9234

WT. 30.0 lbs. VOL. 3,000.0 in³

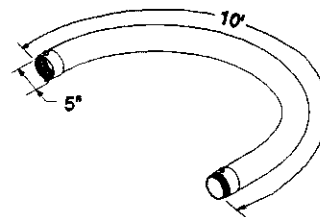

1

Helpful Hints:

Actual Inventory:

**HOSE ASSEMBLY - NON-METALLIC
JUMPER DISCHARGE HOSE FOR P-250
TO WYE-GATE/SIAMESE CONNECTION**

NSN 4210-01-273-4727

WT. 6.8 lbs VOL. 607.5 in³

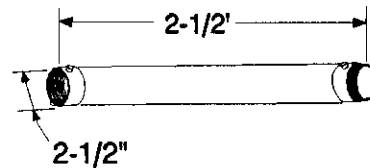

1

Helpful Hints: 2-1/2" male/female NHT couplings.

Actual Inventory:

**HOSE ASSEMBLY - RUBBER EXH. HOSE, BLACK
2" x 20 FT.**

NSN 4210-00-776-0657

WT. 23.0 lbs. VOL. 2,940.0 in³

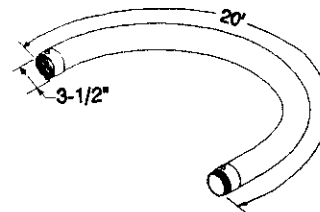

1

Helpful Hints:

Actual Inventory:

PORTABLE PUMP KIT

Quantity
Required

HOSE - 1-1/2" x 50 FT.
NON-METALLIC

NSN 4210-01-131-0249

WT. 25.0 lbs.

VOL. 1,772.0 in.³

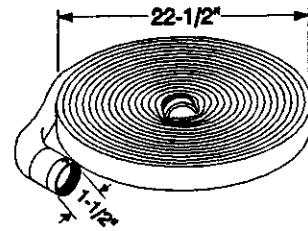

1

Helpful Hints:

Actual Inventory:

HOSE - 2-1/2" x 50 FT.
NON-METALLIC

NSN 4210-01-131-0247

WT. 35.0 lbs.

VOL. 2,890.0 in.³

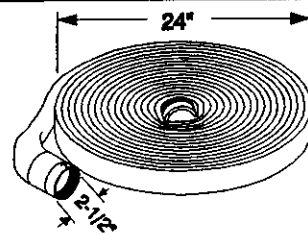

2

Helpful Hints:

Actual Inventory:

PUMP - P-100

NSN 6Y 4320-01-387-2869

WT. 165.0 bs

VOL. 12,091 in.³

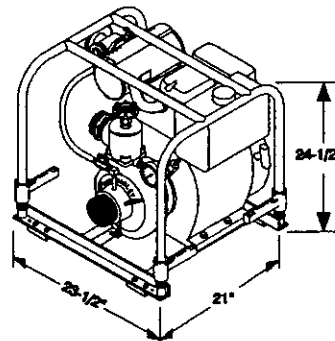

1

Helpful Hints:

Two each 2" x 10' suction hose provided with pump on initial issue.

Actual Inventory:

PORTABLE PUMP KIT

Quantity
Required

PUMP - P-250 MOD 1

NSN 4320-01-186-3377

WT. 155.0 lbs

VOL. 10,080.0 in³

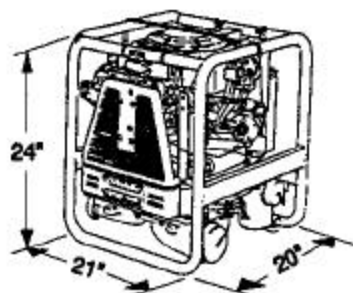

1

Helpful Hints: APL - 2-470004085 P-250 (mod 1) allowance
APL #017600005 P-250 unit repair parts (mod 1)
APL #017600006 P-250 pump end repair parts (mod 1)
APL #668200001 P-250 engine repair parts (mod 1)
APL #47000401516 P-250 accessories / eductor

DELETE

Actual Inventory:

REDUCER - HOSE

4" (M) TO 3" (F)

USE WITH P-250/EDUCTOR

NSN 4730-00-618-8593

WT. 11.0 lbs.

VOL. 132.1 in.³

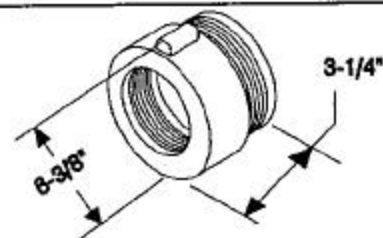

1

Helpful Hints:

Actual Inventory:

REDUCER - HOSE

4" (F) TO 3" (M)

NSN 4210-00-618-8592

WT. 11.0 lbs

VOL. 132.1 in.³

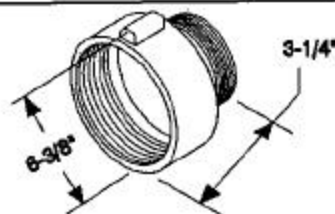

Actual Inventory:

PORTABLE PUMP KIT

Quantity
Required

**VALVE - FOOT/STRAINER
FOR PUMP**

NSN 4820-01-540-2381

WT. 12.5 lbs

VOL. 312.3 in³

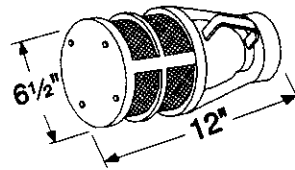

1

Helpful Hints:

Actual Inventory:

**WRENCH - SPANNER
ADJUSTABLE HOOK WITH FIXED PIVOT
RANGE FROM 2" TO 4-3/4"**

NSN 5120-00-277-9076

WT. 2.0 lbs.

VOL. 6.7 in.³

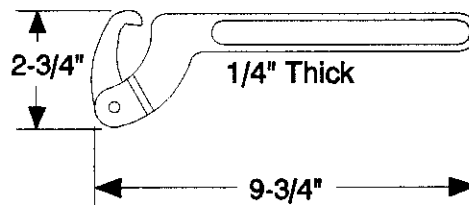

2

Helpful Hints:

Actual Inventory:

**WRENCH - SPANNER
3/4" TO 2"**

NSN 5120-00-288-6468

WT. 1.3 lbs

VOL. 3.0 in³

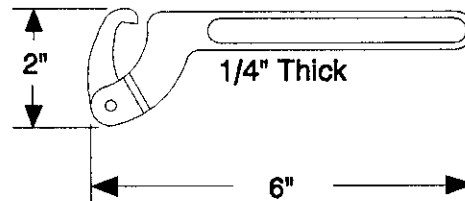

2

Helpful Hints:

Actual Inventory: